

TRADE-TEC



Product

TRPVES08 - TRADE TEC 8LTR POTABLE VESSEL
 TRPVES12 - TRADE TEC 12LTR POTABLE VESSEL
 TRPVES18 - TRADE TEC 18LTR POTABLE VESSEL
 TRPVES24 - TRADE TEC 24LTR POTABLE VESSEL
 TRPVES35 - TRADE TEC 35LTR POTABLE VESSEL
 TRPVES50 - TRADE TEC 50LTR POTABLE VESSEL
 TRPVES80 - TRADE TEC 80LTR POTABLE VESSEL
 TRPVES100 - TRADE TEC 100LTR POTABLE VESSEL

Technical Specification

Max Working Pressure: 8 Bar
Max Working Temperature: 99°C
Max Membrane Temperature: 70°C
Pre Charge: 8 - 24 Litre 2.5 Bar
 35 - 100 Litre 1.5 Bar

Features

Powder coated exterior finish
100% Factory tested
Interchangeable membrane
Supplied with mounting bracket
Welded centre seam
Galvanized steel flange
2 years manufacturing warranty

Drawings

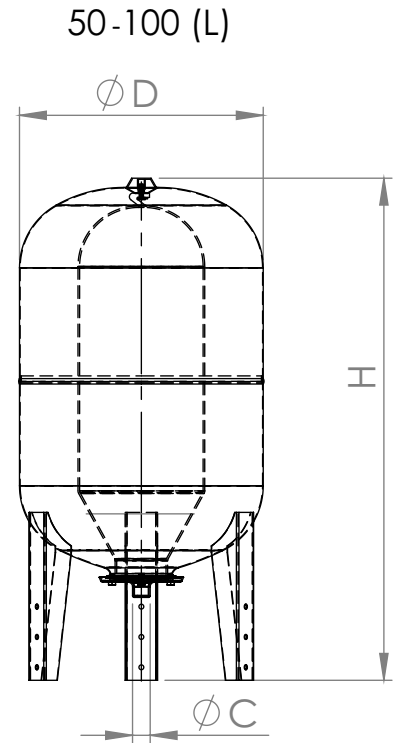
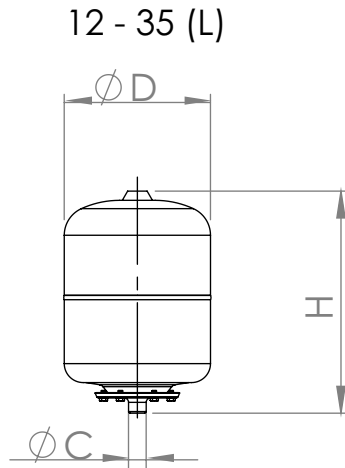
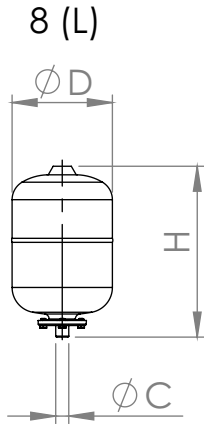

Nominal volume (litres)	H (mm)	øD (mm)	E (mm)	L (mm)	øC
8	335	199	-	-	G3/4
12	310	270	-	-	G3/4
19	411	270	-	-	G3/4
24	485	270	-	-	G3/4
35	420	380	-	-	G1
50	788	380	180	-	G1
80	878	380	170	-	G1
100	848	450	153	-	G1

Intatec, Airfield Industrial Estate, Hixon, Stafford, ST18 0PF
T. 01889 272180 F. 01889 272181 E. sales@intatec.co.uk
www.intatec.co.uk